

Metallized Polypropylene (PP) - Capacitors for DC-Link Applications. Capacitances from 1.0 μF to 400 μF . Rated Voltages from 400 VDC to 1300 VDC.

Special Features

- Capacitances up to 400 μF
- High volume/capacitance ratio
- Excellent self-healing properties
- Very low dissipation factor
- High reliability
- 2-pin and 4-pin contact configuration (plate versions on request)
- AEC-Q200 qualified
- According to RoHS 2011/65/EU

Typical Applications

As intermediate circuit capacitor e.g. in high power converter technology, power supplies, solar inverters etc.

Construction

Dielectric:

Polypropylene (PP) film

Capacitor electrodes:

Vacuum-deposited

Internal construction:

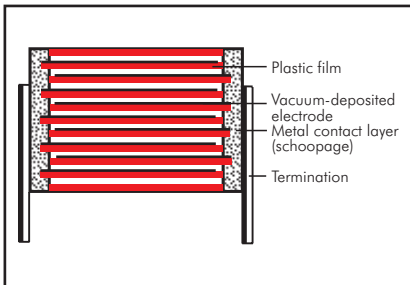

Encapsulation:

Solvent-resistant, flame-retardant plastic case with epoxy resin seal, UL 94 V-0

Terminations:

Tinned wire (plate versions on request).

Marking:

Colour: Red. Marking: Black.

Electrical Data

Capacitance range: 1 μF to 400 μF
(intermediate values on request)

Rated voltages: 400VDC, 500VDC, 600VDC, 800VDC, 900VDC, 1100VDC, 1300VDC

Capacitance tolerances: $\pm 20\%$, $\pm 10\%$, $\pm 5\%$

Operating temperature range:
-55° C to +105° C (hot spot including self-heating)

Climatic test category: 55/085/56
in accordance with IEC

Dissipation factors at +20° C:

PCM	1 kHz	10 kHz
27.5	$\leq 15 \times 10^{-4}$	$\leq 160 \times 10^{-4}$
37.5	$\leq 30 \times 10^{-4}$	$\leq 210 \times 10^{-4}$
52.5	$\leq 50 \times 10^{-4}$	$\leq 260 \times 10^{-4}$

Voltage and current derating:

A derating factor of 1.35% per K must be applied from +85° C for DC voltages and from +70° C for AC currents (I_{rms}). Additionally a derating factor of 4.5% per K must be applied from +85° C for AC currents (I_{rms})

Reliability: Operational life > 100 000 hours (U_r and 70° C)

Failure rate λ_0 (0.5 $\times U_r$ and 40° C)

$\Pi = C_N [\mu\text{F}] \times U_r [\text{V}] $	λ_0
$\Pi \leq 10\,000$	< 2 fit
$10\,000 < \Pi \leq 25\,000$	< 5 fit
$25\,000 < \Pi \leq 50\,000$	< 10 fit
$50\,000 < \Pi \leq 100\,000$	< 20 fit
$\Pi > 100\,000$	< 30 fit

Maximum pulse rise time:

PCM	max. pulse rise time V/ μsec at $T_A < 40^\circ\text{C}$						
	400 VDC	500 VDC	600 VDC	800 VDC	900 VDC	1100 VDC	1300 VDC
27.5	11	15	27	29	35	43	50
37.5	8	10	19	21	22	29	35
52.5	5	7	13	15	18	21	25

for pulses equal to the rated voltage

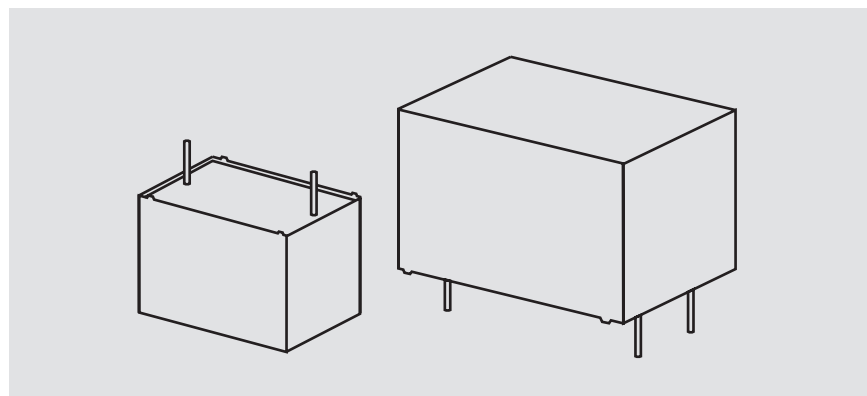

Insulation resistance at +20° C:
 $\geq 30\,000$ sec ($M\Omega \times \mu\text{F}$)

Measuring voltage: 100 V/1 min.

Test voltage:

1.2 U_r , 2sec

Dielectric absorption: 0.05 %

Specific dissipation:

Box size W x H x L in mm	Specific dissipation in Watts per K above the ambient temperature
9x19x31.5	0.021
11x21x31.5	0.025
13x24x31.5	0.030
15x26x31.5	0.034
17x29x31.5	0.039
27x15x41.5	0.043
17x34.5x31.5	0.044
20x39.5x31.5	0.053
19x32x41.5	0.054
20x39.5x41.5	0.065
24x45.5x41.5	0.080
31x46x41.5	0.092
35x50x41.5	0.106
40x55x41.5	0.123
35x50x57	0.132
45x55x57	0.164
45x65x57	0.184

Packing

Packing units at the end of the catalogue

For further details and graphs please refer to Technical Information.

Continuation

General Data

Capacitance	400 VDC (70° C) / 300 VDC (85° C)					I _s A	I _{rms} * (10 kHz)* A	ESR (10 kHz)* mΩ	Part number
	W	H	L	PCM**	Pin				
1 μF	9	19	31.5	27.5	2	11	1	238.7	DCP4G041006A
2 "	9	19	31.5	27.5	2	22	1.5	119.4	DCP4G042006A
3 "	9	19	31.5	27.5	2	33	1.5	79.6	DCP4G043006A
4 "	9	19	31.5	27.5	2	44	2	59.7	DCP4G044006A
5 "	9	19	31.5	27.5	2	55	2	47.7	DCP4G045006A
7 "	9	19	31.5	27.5	2	77	2.5	34.1	DCP4G047006A
10 μF	11	21	31.5	27.5	2/4	110	3.5	23.9	DCP4G051006B
15 "	13	24	31.5	27.5	2/4	165	4.5	15.9	DCP4G051506D
20 "	15	26	31.5	27.5	2/4	220	5.5	11.9	DCP4G052006F
25 "	17	29	31.5	27.5	2/4	275	6.5	9.5	DCP4G052506G
30 "	17	34.5	31.5	27.5	2/4	330	7	8	DCP4G053006I
40 "	20	39.5	31.5	27.5	2/4	440	9.5	6	DCP4G054006J
50 "	20	39.5	41.5	37.5	2/4	400	11	5.4	DCP4G055007G
60 "	20	39.5	41.5	37.5	2/4	480	11.5	4.8	DCP4G056007G
70 "	24	45.5	41.5	37.5	2/4	560	15	3.6	DCP4G057007H
80 "	24	45.5	41.5	37.5	2/4	640	17	2.7	DCP4G058007H
90 "	24	45.5	41.5	37.5	2/4	720	17.5	2.6	DCP4G059007H
100 μF	31	46	41.5	37.5	2/4	800	19	2.5	DCP4G061007I
120 "	31	46	41.5	37.5	2/4	960	20	2.3	DCP4G061207I
140 "	35	50	41.5	37.5	2/4	1120	22.5	2.1	DCP4G061407J
150 "	35	50	41.5	37.5	2/4	1200	23	2	DCP4G061507J
160 "	40	55	41.5	37.5	2/4	1280	28	1.6	DCP4G061607K
180 "	40	55	41.5	37.5	2/4	1440	29.5	1.4	DCP4G061807K
190 "	40	55	41.5	37.5	2/4	1520	31.5	1.2	DCP4G061907K
200 "	40	55	41.5	37.5	2/4	1600	32.5	1.2	DCP4G062007K
220 "	35	50	57	52.5	4	1100	27	1.8	DCP4G062209F
250 "	45	55	57	52.5	4	1250	32	1.6	DCP4G062509H
270 "	45	55	57	52.5	4	1350	33.5	1.5	DCP4G062709H
300 "	45	55	57	52.5	4	1500	35	1.3	DCP4G063009H
330 "	45	65	57	52.5	4	1650	37	1.2	DCP4G063309J
350 "	45	65	57	52.5	4	1750	40	1.1	DCP4G063509J
370 "	45	65	57	52.5	4	1850	41.5	1.1	DCP4G063709J
400 "	45	65	57	52.5	4	2000	43	1	DCP4G064009J

* General guide

* Permissible I_{rms} at 10° C internal temperature rise (general guide)

** PCM = Printed circuit module = pin spacing

Dims. in mm.

Part number completion:	
Version code:	2-pin = D2 4-pin = D4
Tolerance:	20 % = M 10 % = K 5 % = J
Packing:	bulk = S
Pin length:	6-2 = SD
Taped version see page 149.	

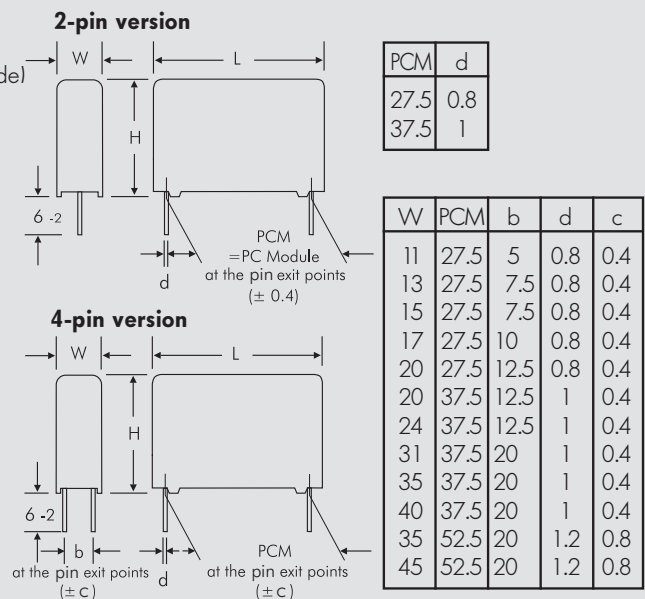

Rights reserved to amend design data without prior notification.

Continuation page 124



Continuation

General Data

Capacitance	W	H	L	PCM**	Pin	500 VDC (70° C) / 400 VDC (85° C)			Part number
						I _S A	I _{rms} * (10 kHz)* A	ESR (10 kHz)* mΩ	
1 μF	9	19	31.5	27.5	2	15	1	238.7	DCP4H141006A
2 "	9	19	31.5	27.5	2	30	1.5	119.4	DCP4H142006A
3 "	9	19	31.5	27.5	2	45	1.5	79.6	DCP4H143006A
5 "	9	19	31.5	27.5	2	75	2.5	47.7	DCP4H145006A
7 "	11	21	31.5	27.5	2/4	105	3	34.1	DCP4H147006B
8 "	13	24	31.5	27.5	2/4	120	3	29.8	DCP4H148006D
10 μF	13	24	31.5	27.5	2/4	150	4	23.9	DCP4H151006D
12 "	15	26	31.5	27.5	2/4	180	4	19.9	DCP4H151206F
15 "	17	29	31.5	27.5	2/4	225	5	15.9	DCP4H151506G
20 "	17	34.5	31.5	27.5	2/4	300	6	11.9	DCP4H152006I
22 "	20	39.5	31.5	27.5	2/4	330	7	10.9	DCP4H152206J
25 "	20	39.5	31.5	27.5	2/4	375	7.5	9.5	DCP4H152506J
30 "	20	39.5	41.5	37.5	2/4	300	9	7.9	DCP4H153007G
35 "	20	39.5	41.5	37.5	2/4	350	8.5	9.1	DCP4H153507G
40 "	20	39.5	41.5	37.5	2/4	400	10	5.7	DCP4H154007G
	24	45.5	41.5	37.5	2/4	400	10	8	DCP4H154007H
45 "	24	45.5	41.5	37.5	2/4	450	12.5	5	DCP4H154507H
50 "	24	45.5	41.5	37.5	2/4	500	13	4.8	DCP4H155007H
55 "	24	45.5	41.5	37.5	2/4	550	14	4	DCP4H155507H
60 "	31	46	41.5	37.5	2/4	600	14	4.7	DCP4H156007I
65 "	31	46	41.5	37.5	2/4	650	16.5	3.3	DCP4H156507I
70 "	31	46	41.5	37.5	2/4	700	18	2.9	DCP4H157007I
75 "	31	46	41.5	37.5	2/4	750	17	3.2	DCP4H157507I
80 "	31	46	41.5	37.5	2/4	800	18	2.8	DCP4H158007I
85 "	35	50	41.5	37.5	2/4	850	10.5	3.2	DCP4H158507J
90 "	35	50	41.5	37.5	2/4	900	21	2.4	DCP4H159007J
95 "	35	50	41.5	37.5	2/4	950	21.5	2.2	DCP4H159507J
100 μF	35	50	41.5	37.5	2/4	1000	24	1.9	DCP4H161007J
	35	50	57	52.5	4	700	18	4	DCP4H161009F
110 "	40	55	41.5	37.5	2/4	1100	19	2.9	DCP4H161107K
	35	50	57	52.5	4	770	19	3.6	DCP4H161109F
120 "	40	55	41.5	37.5	2/4	1200	22.5	2.7	DCP4H161207K
	35	50	57	52.5	4	840	20	3.3	DCP4H161209F
130 "	40	55	41.5	37.5	2/4	1300	23	2.4	DCP4H161307K
	35	50	57	52.5	4	910	21	3.1	DCP4H161309F
140 "	35	50	57	52.5	4	980	21.5	2.8	DCP4H161409F
150 "	35	50	57	52.5	4	1050	22.5	2.7	DCP4H161509F
160 "	45	55	57	52.5	4	1120	25.5	2.5	DCP4H161609H
170 "	45	55	57	52.5	4	1190	26.5	2.3	DCP4H161709H
180 "	45	55	57	52.5	4	1260	27	2.2	DCP4H161809H
190 "	45	55	57	52.5	4	1330	28	2.1	DCP4H161909H
200 "	45	55	57	52.5	4	1400	28.5	2	DCP4H162009H
210 "	45	55	57	52.5	4	1470	29.5	1.9	DCP4H162109H
220 "	45	65	57	52.5	4	1540	32	1.8	DCP4H162209J
240 "	45	65	57	52.5	4	1680	33.5	1.7	DCP4H162409J

* General guide

* Permissible I_{rms} at 10° C internal temperature rise (general guide)

** PCM = Printed circuit module = pin spacing

Dims. in mm.

Rights reserved to amend design data without prior notification.

Continuation page 125

Continuation

General Data

Capacitance	600 VDC (70° C) / 450 VDC (85° C)					Part number			
	W	H	L	PCM**	Pin		I_s A	I_{rms} (10 kHz)* A	ESR (10 kHz)* mΩ
2 μF	9	19	31.5	27.5	2	54	2	56	DCP41042006A
5 "	13	24	31.5	27.5	2/4	135	3.5	22	DCP41045006D
7 "	15	26	31.5	27.5	2/4	189	4.5	16	DCP41047006F
10 μF	17	29	31.5	27.5	2/4	270	6	11	DCP41051006G
	27	15	41.5	37.5	2/4	190	6.5	10	DCP41051007M
15 "	17	34.5	31.5	27.5	2/4	405	7.5	7.4	DCP41051506I
20 "	20	39.5	31.5	27.5	2/4	540	9	6.2	DCP41052006J
	20	39.5	41.5	37.5	2/4	380	10	6.2	DCP41052007G
25 "	20	39.5	41.5	37.5	2/4	475	11.5	5	DCP41052507G
30 "	24	45.5	41.5	37.5	2/4	570	14	4.1	DCP41053007H
35 "	24	45.5	41.5	37.5	2/4	665	14.5	3.8	DCP41053507H
40 "	31	46	41.5	37.5	2/4	760	16.5	3.3	DCP41054007I
45 "	31	46	41.5	37.5	2/4	855	17	3.2	DCP41054507I
50 "	35	50	41.5	37.5	2/4	950	19	2.9	DCP41055007J
55 "	35	50	41.5	37.5	2/4	1045	17	3.8	DCP41055507J
60 "	35	50	41.5	37.5	2/4	1140	17.5	3.4	DCP41056007J
65 "	40	55	41.5	37.5	2/4	1235	19.5	3.3	DCP41056507K
	35	50	57	52.5	4	845	20	3.3	DCP41056509F
70 "	40	55	41.5	37.5	2/4	1330	20	3.1	DCP41057007K
	35	50	57	52.5	4	910	20.5	3.1	DCP41057009F
75 "	40	55	41.5	37.5	2/4	1425	20.5	3	DCP41057507K
	35	50	57	52.5	4	975	21	3	DCP41057509F
80 "	40	55	41.5	37.5	2/4	1520	22	2.6	DCP41058007K
	35	50	57	52.5	4	1040	22	2.6	DCP41058009F
85 "	35	50	57	52.5	4	1105	22.5	2.1	DCP41058509F
90 "	35	50	57	52.5	4	1170	23.5	1.9	DCP41059009F
95 "	45	55	57	52.5	4	1235	24	2.8	DCP41059509H
100 μF	45	55	57	52.5	4	1300	25	2.6	DCP41061009H
110 "	45	55	57	52.5	4	1430	26.5	2.3	DCP41061109H
115 "	45	65	57	52.5	4	1495	27.5	2.5	DCP41061159J
120 "	45	65	57	52.5	4	1560	28	2.3	DCP41061209J
130 "	45	65	57	52.5	4	1690	29.5	2.1	DCP41061309J
140 "	45	65	57	52.5	4	1820	31	1.9	DCP41061409J
150 "	45	65	57	52.5	4	1950	33	1.7	DCP41061509J

* General guide

** PCM = Printed circuit module = pin spacing

Dims. in mm.

Part number completion:	
Version code:	2-pin = D2 4-pin = D4
Tolerance:	20 % = M 10 % = K 5 % = J
Packing:	bulk = S
Pin length:	6-2 = SD
Taped version see page 149.	

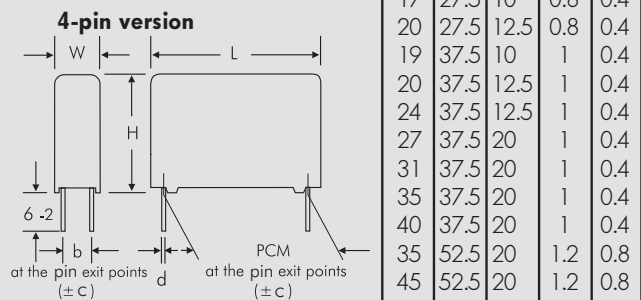
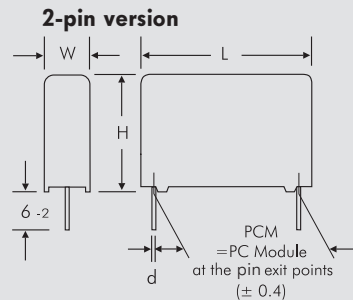

Rights reserved to amend design data without prior notification.



Continuation

General Data

Capacitance	800 VDC (70° C) / 700 VDC (85° C)					I _s A	I _{rms} (10 kHz)* A	ESR (10 kHz)* mΩ	Part number
	W	H	L	PCM**	Pin				
2 μF	9	19	31.5	27.5	2	58	2	52	DCP4L042006A
5 "	13	24	31.5	27.5	2/4	145	4	21	DCP4L045006D
7 "	17	29	31.5	27.5	2/4	203	5	15	DCP4L047006G
10 μF	17	34.5	31.5	27.5	2/4	290	6.5	10	DCP4L051006I
15 "	20	39.5	31.5	27.5	2/4	435	9	6.9	DCP4L051506J
	20	39.5	41.5	37.5	2/4	315	9.5	6.9	DCP4L051507G
20 "	20	39.5	41.5	37.5	2/4	420	10	6.2	DCP4L052007G
25 "	24	45.5	41.5	37.5	2/4	525	12.5	5	DCP4L052507H
30 "	24	45.5	41.5	37.5	2/4	630	14	4.1	DCP4L053007H
35 "	31	46	41.5	37.5	2/4	735	15.5	3.8	DCP4L053507I
40 "	31	46	41.5	37.5	2/4	840	16.5	3.3	DCP4L054007I
45 "	35	50	41.5	37.5	2/4	945	17.5	3.4	DCP4L054507J
50 "	35	50	41.5	37.5	2/4	1050	19	3	DCP4L055007J
55 "	40	55	41.5	37.5	2/4	1155	19.5	3.2	DCP4L055507K
	35	50	57	52.5	4	825	20.4	3.2	DCP4L055509F
60 "	40	55	41.5	37.5	2/4	1260	20.5	2.9	DCP4L056007K
	35	50	57	52.5	4	900	21.5	2.9	DCP4L056009F
65 "	35	50	57	52.5	4	975	22.5	2.2	DCP4L056509F
70 "	45	55	57	52.5	4	1050	23.5	3	DCP4L057009H
75 "	45	55	57	52.5	4	1125	24	2.9	DCP4L057509H
80 "	45	55	57	52.5	4	1200	24.5	3	DCP4L058009H
85 "	45	65	57	52.5	4	1275	25	2.6	DCP4L058509J
90 "	45	65	57	52.5	4	1350	25.5	2.5	DCP4L059009J
95 "	45	65	57	52.5	4	1425	26	2.4	DCP4L059509J
100 μF	45	65	57	52.5	4	1500	26.5	2.3	DCP4L061009J
110 "	45	65	57	52.5	4	1650	27.5	2.2	DCP4L061109J
115 "	45	65	57	52.5	4	1725	28	2.1	DCP4L061159J

Capacitance	900 VDC (70° C) / 760 VDC (85° C)					I _s A	I _{rms} (10 kHz)* A	ESR (10 kHz)* mΩ	Part number
	W	H	L	PCM**	Pin				
2 μF	11	21	31.5	27.5	2/4	70	2.5	44	DCP4N042006B
5 "	17	29	31.5	27.5	2/4	175	4.5	18	DCP4N045006G
7 "	17	34.5	31.5	27.5	2/4	245	6	13	DCP4N047006I
10 μF	20	39.5	31.5	27.5	2/4	350	8	8.8	DCP4N051006J
	20	39.5	41.5	37.5	2/4	220	8.5	8.8	DCP4N051007G
15 "	20	39.5	41.5	37.5	2/4	330	10.5	5.8	DCP4N051507G
20 "	24	45.5	41.5	37.5	2/4	440	13	4.8	DCP4N052007H
25 "	31	46	41.5	37.5	2/4	550	15.5	3.8	DCP4N052507I
30 "	31	46	41.5	37.5	2/4	660	15.5	3.7	DCP4N053007I
35 "	35	50	41.5	37.5	2/4	770	18	3.2	DCP4N053507J
40 "	40	55	41.5	37.5	2/4	880	19.5	3.2	DCP4N054007K
	35	50	57	52.5	4	720	20.5	3.2	DCP4N054009F
45 "	35	50	57	52.5	4	810	21	2.8	DCP4N054509F
50 "	35	50	57	52.5	4	900	22	3.3	DCP4N055009F
55 "	35	50	57	52.5	4	990	22.5	3.2	DCP4N055509F
	45	55	57	52.5	4	990	22.5	3.2	DCP4N055509H
60 "	45	55	57	52.5	4	1080	23	3	DCP4N056009H
65 "	45	55	57	52.5	4	1170	24	2.9	DCP4N056509H
70 "	45	65	57	52.5	4	1260	24.5	3.3	DCP4N057009J
75 "	45	65	57	52.5	4	1350	25	2.9	DCP4N057509J
80 "	45	65	57	52.5	4	1440	25.5	2.8	DCP4N058009J

* General guide

** PCM = Printed circuit module = pin spacing

Dims. in mm.

Rights reserved to amend design data without prior notification.

Continuation

General Data

Capacitance	W	H	L	PCM**	Pin	1100 VDC (70° C) / 920 VDC (85° C)			Part number
						I_s A	I_{rms} (10 kHz)* A	ESR (10 kHz)* mΩ	
2 μF	13	24	31.5	27.5	2/4	86	3	36	DCP4P042006D
3 "	15	26	31.5	27.5	2/4	129	4	23	DCP4P043006F
5 "	17	34.5	31.5	27.5	2/4	215	5.5	14	DCP4P045006I
7 "	20	39.5	31.5	27.5	2/4	301	7.5	10	DCP4P047006J
	19	32	41.5	37.5	2/4	203	7.5	10	DCP4P047007F
10 μF	20	39.5	41.5	37.5	2/4	290	9.5	7.2	DCP4P051007G
15 "	31	46	41.5	37.5	2/4	435	13	5.4	DCP4P051507I
20 "	31	46	41.5	37.5	2/4	580	14	5.2	DCP4P052007I
	35	50	41.5	37.5	2/4	580	15	4.7	DCP4P052007J
25 "	40	55	41.5	37.5	2/4	725	16.5	4.6	DCP4P052507K
30 "	35	50	57	52.5	4	630	17.5	4.4	DCP4P053009F
35 "	35	50	57	52.5	4	735	18	4	DCP4P053509F
40 "	45	55	57	52.5	4	840	19	4.5	DCP4P054009H
45 "	45	55	57	52.5	4	945	20	4.1	DCP4P054509H
50 "	45	65	57	52.5	4	1050	21	4.1	DCP4P055009J
55 "	45	65	57	52.5	4	1150	22	3.8	DCP4P055509J
60 "	45	65	57	52.5	4	1260	23	3.5	DCP4P056009J

Capacitance	W	H	L	PCM**	Pin	1300 VDC (70° C) / 1100 VDC (85° C)			Part number
						I_s A	I_{rms} (10 kHz)* A	ESR (10 kHz)* mΩ	
2 μF	15	26	31.5	27.5	2/4	100	3	36	DCP4R242006F
5 "	20	39.5	31.5	27.5	2/4	250	6	14	DCP4R245006J
	20	39.5	41.5	37.5	2/4	175	7	14	DCP4R245007G
7 "	20	39.5	41.5	37.5	2/4	245	8	10	DCP4R247007G
10 μF	24	45.5	41.5	37.5	2/4	350	10.5	7.2	DCP4R251007H
15 "	31	46	41.5	37.5	2/4	525	14	4.8	DCP4R251507I
20 "	40	55	41.5	37.5	2/4	700	17.5	4	DCP4R252007K
	35	50	57	52.5	4	500	18	4	DCP4R252009F
25 "	35	50	57	52.5	4	625	19	3.6	DCP4R252509F
30 "	45	55	57	52.5	4	750	20	4	DCP4R253009H
35 "	45	65	57	52.5	4	875	21	4.1	DCP4R253509J
40 "	45	65	57	52.5	4	1000	22	3.7	DCP4R254009J

* General guide

** PCM = Printed circuit module = pin spacing

Dims. in mm.

Part number completion:	
Version code:	2-pin = D2 4-pin = D4
Tolerance:	20 % = M 10 % = K 5 % = J
Packing:	bulk = S
Pin length:	6-2 = SD
Taped version see page 149.	

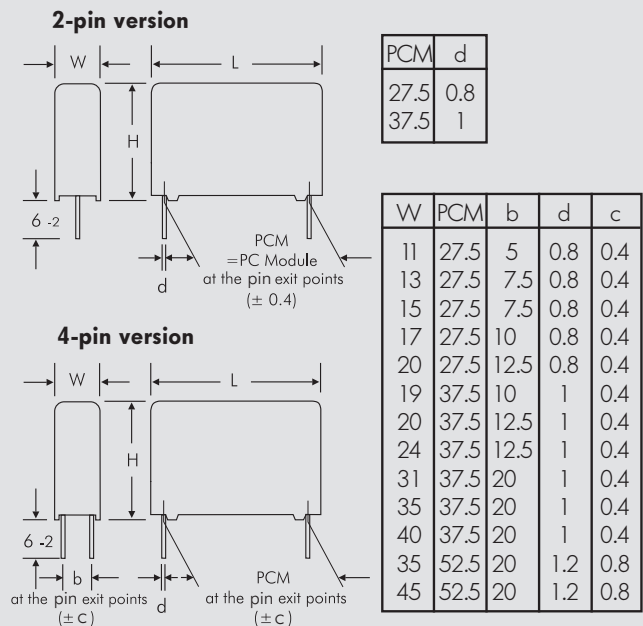

Rights reserved to amend design data without prior notification.

Recommendation for Processing and Application of Through-Hole Capacitors

Soldering Process

Internal temperature of the capacitor must be kept as follows:

Polyester: preheating: $T_{max.} \leq 125^{\circ}C$
soldering: $T_{max.} \leq 135^{\circ}C$

Polypropylene: preheating: $T_{max.} \leq 100^{\circ}C$
soldering: $T_{max.} \leq 110^{\circ}C$

Single wave soldering

Soldering bath temperature: $T < 260^{\circ}C$

Dwell time: $t < 5 \text{ sec}$

Double wave soldering

Soldering bath temperature: $T < 260^{\circ}C$

Dwell time: $\Sigma t < 5 \text{ sec}$

Due to different soldering processes and heat requirements the graphs are to be regarded as a recommendation only.

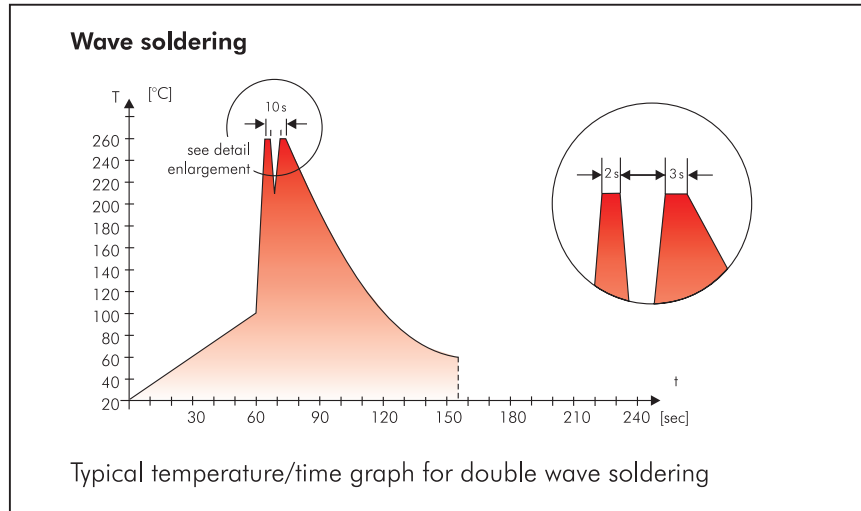

WIMA Quality and Environmental Philosophy

ISO 9001:2015 Certification

ISO 9001:2015 is an international basic standard of quality assurance systems for all branches of industry. The approval according to ISO 9001:2015 of our factories by the infaz (Institut für Auditierung und Zertifizierung) certifies that organisation, equipment and monitoring of quality assurance in our factories correspond to internationally recognized standards.

WIMA WPCS

The WIMA Process Control System (WPCS) is a quality surveillance and optimization system developed by WIMA. WPCS is a major part of the quality-oriented WIMA production. Points of application during production process:

- incoming material inspection
- metallization
- film inspection
- schoopage
- pre-healing
- pin attachment
- cast resin preparation/encapsulation
- 100% final inspection
- Testing as per customer requirements

WIMA Environmental Policy

All WIMA capacitors, irrespective of whether through-hole devices or SMD, are made of environmentally friendly materials. Neither during manufacture nor in the product itself any toxic substances are used, e.g.

- Lead
- PCB
- CFC
- Hydrocarbon chloride
- Chromium 6+
- PBB/PBDE
- Arsenic
- Cadmium
- Mercury
- etc.

We merely use pure, recyclable materials for packing our components, such as:

- carton
- cardboard
- adhesive tape made of paper
- polystyrene

We almost completely refrain from using packing materials such as:

- adhesive tapes made of plastic
- metal clips

RoHS Compliance

According to the RoHS Directive 2011/65/EU as amended from time to time certain hazardous substances like e.g. lead, cadmium, mercury must not be used any longer in electronic equipment as of July 1st, 2006. For the sake of the environment WIMA has refrained from using such substances since years already.



WIMA Kondensatoren sind bleifrei konform RoHS 2011/65/EU

WIMA capacitors are lead free in accordance with RoHS 2011/65/EU

Tape for lead-free WIMA capacitors

DIN EN ISO 14001:2004

WIMA's environmental management has been established in accordance with the guidelines of DIN EN ISO 14001:2004 to optimize the production processes with regard to energy and resources.

Typical Dimensions for Taping Configuration

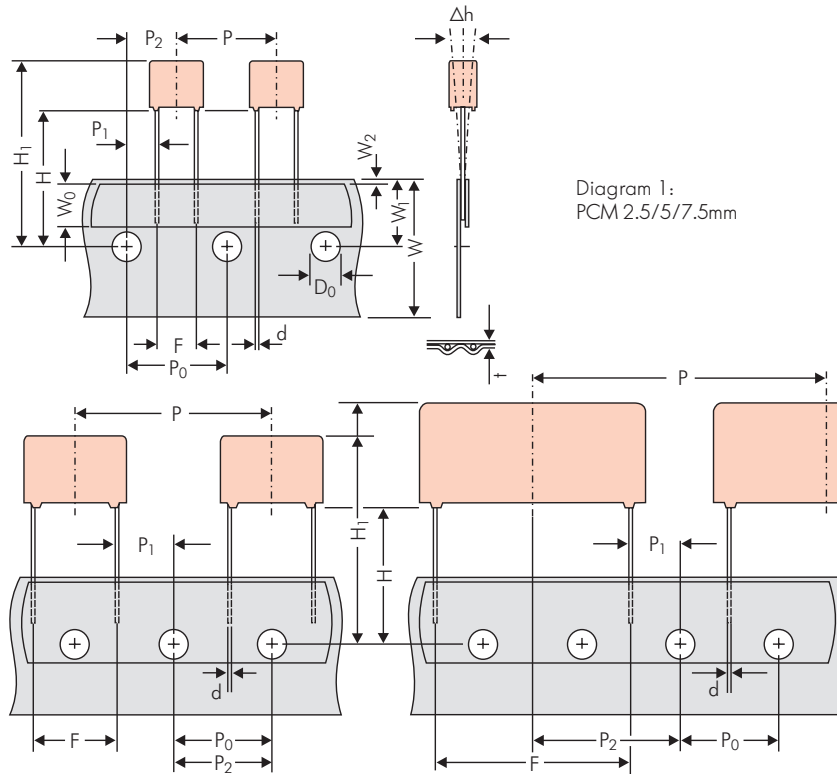

Diagram 1:
PCM 2.5/5/7.5mm

Diagram 2: PCM 10/15 mm

Diagram 3: PCM 22.5 and 27.5*mm

*PCM 27.5 taping possible with two feed holes between components

Designation	Symbol	Dimensions for Radial Taping							
		PCM 2.5 taping	PCM 5 taping	PCM 7.5 taping	PCM 10 taping*	PCM 15 taping*	PCM 22.5 taping	PCM 27.5 taping	
Carrier tape width	W	18.0 ±0.5	18.0 ±0.5	18.0 ±0.5	18.0 ±0.5	18.0 ±0.5	18.0 ±0.5	18.0 ±0.5	
Hold-down tape width	W ₀	6.0 for hot-sealing adhesive tape	6.0 for hot-sealing adhesive tape	12.0 for hot-sealing adhesive tape	12.0 for hot-sealing adhesive tape	12.0 for hot-sealing adhesive tape	12.0 for hot-sealing adhesive tape	12.0 for hot-sealing adhesive tape	
Hole position	W ₁	9.0 ±0.5	9.0 ±0.5	9.0 ±0.5	9.0 ±0.5	9.0 ±0.5	9.0 ±0.5	9.0 ±0.5	
Hold-down tape position	W ₂	0.5 to 3.0 max.	0.5 to 3.0 max.	0.5 to 3.0 max.	0.5 to 3.0 max.	0.5 to 3.0 max.	0.5 to 3.0 max.	0.5 to 3.0 max.	
Feed hole diameter	D ₀	4.0 ±0.2	4.0 ±0.2	4.0 ±0.2	4.0 ±0.2	4.0 ±0.2	4.0 ±0.2	4.0 ±0.2	
Pitch of component	P	12.7 ±1.0	12.7 ±1.0	12.7 ±1.0	25.4 ±1.0	25.4 ±1.0	38.1 ±1.5	38.1 ±1.5 or 50.8 ±1.5	
Feed hole pitch	P ₀	12.7 ±0.3 cumulative pitch error max. 1.0 mm/20 pitch	12.7 ±0.3 cumulative pitch error max. 1.0 mm/20 pitch	12.7 ±0.3 cumulative pitch error max. 1.0 mm/20 pitch	12.7 ±0.3 cumulative pitch error max. 1.0 mm/20 pitch	12.7 ±0.3 cumulative pitch error max. 1.0 mm/20 pitch	12.7 ±0.3 cumulative pitch error max. 1.0 mm/20 pitch	12.7 ±0.3 cumulative pitch error max. 1.0 mm/20 pitch	
Feed hole centre to pin	P ₁	5.1 ±0.5	3.85 ±0.7	2.6 ±0.7	7.7 ±0.7	5.2 ±0.7	7.8 ±0.7	5.3 ±0.7	
Hole centre to component centre	P ₂	6.35 ±1.3	6.35 ±1.3	6.35 ±1.3	12.7 ±1.3	12.7 ±1.3	19.05 ±1.3	19.05 ±1.3	
Feed hole centre to bottom edge of the component	H	16.5 ±0.3 18.5 ±0.5	16.5 ±0.3 18.5 ±0.5	16.5 ±0.5 18.5 ±0.5	16.5 ±0.5 18.5 ±0.5	16.5 ±0.5 18.5 ±0.5	16.5 ±0.5 18.5 ±0.5	16.5 ±0.5 18.5 ±0.5	
Feed hole centre to top edge of the component	H ₁	H+H _{component} < H ₁ 32.25 max.	H+H _{component} < H ₁ 32.25 max.	H+H _{component} < H ₁ 24.5 to 31.5	H+H _{component} < H ₁ 25.0 to 31.5	H+H _{component} < H ₁ 26.0 to 37.0	H+H _{component} < H ₁ 30.0 to 43.0	H+H _{component} < H ₁ 35.0 to 45.0	
Pin spacing at upper edge of carrier tape	F	2.5 ±0.5	5.0 ^{+0.8} _{-0.2}	7.5 ±0.8	10.0 ±0.8	15 ±0.8	22.5 ±0.8	27.5 ±0.8	
Pin diameter	d	0.4 ±0.05	0.5 ±0.05	0.5 ±0.05 or 0.6 ^{+0.06} _{-0.05}	0.5 ±0.05 or 0.6 ^{+0.06} _{-0.05}	0.8 ^{+0.08} _{-0.05}	0.8 ^{+0.08} _{-0.05}	0.8 ^{+0.08} _{-0.05}	
Component alignment	Δh	± 2.0 max.	± 2.0 max.	± 3.0 max.	± 3.0 max.	± 3.0 max.	± 3.0 max.	± 3.0 max.	
Total tape thickness	t	0.6 ±0.2	0.6 ±0.2	0.6 ±0.2	0.6 ±0.2	0.6 ±0.2	0.6 ±0.2	0.6 ±0.2	
Package (see also page 150)	ROLL/AMMO				AMMO				
	REEL	φ 360 max. φ 30 ±1	B 52 ±2 58 ±2 } depending on comp. dimensions	REEL φ 360 max. φ 30 ±1					52 ±2 58 ±2 or 66 ±2 } depending on PCM and component dimensions
Unit	see details page 151.								

Dims in mm.

* Diameter of pins see General Data.

* PCM 10 and PCM 15 can be crimped to PCM 7.5.

Position of components according to PCM 7.5 (sketch 11). P₀ = 12.7 or 15.0 is possible

Please clarify customer-specific deviations with the manufacturer.

Types of Tape Packaging of Capacitors for Automatic Radial Insertion

■ ROLL Packaging

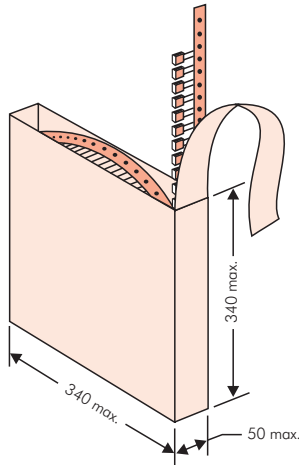

■ AMMO Packaging

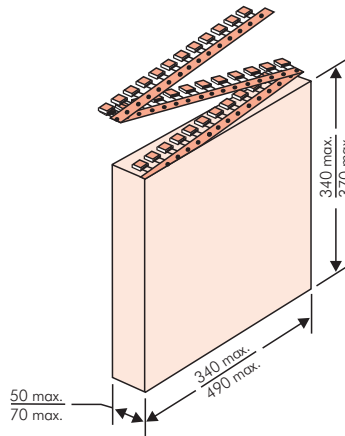

■ REEL Packaging

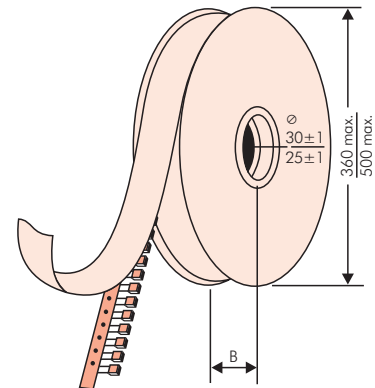

BAR CODE (Labelling)

Labelling of package units in plain text and with alphanumerical Bar Code

Scanner decoding of

- WIMA supplier number
- Customer's P/O number
- Customer's part number
- WIMA confirmation number
- WIMA part number
- Lot number
- Date code
- Quantity

In addition part description of

- article
- capacitance value
- rated voltage
- dimensions
- capacitance tolerance
- packing

as well as gross weight and customer's name are indicated in plain text.

WIMA Best Capacitors Made In Germany		Werk Unna
Supplier-ID: 123456789	RoHS 2011/65/EU	Date Code: 08.10.10
Purchase Order No. (P/O): Bestellung xyz		Quantity: 5.000
Customer Part No.: KUNDETEILENUMMER		Customer No.: 0000100002
		Gross Weight [g]: 1870
WIMA Confirmation No.: 0001004053000100	WIMA Part No.: MKS2C034701C00K8SD	
Handling Unit: MKS 2	QTY: 5.000	COO: DE
	MKS 2 0.47 µF 63 VDC 3.5x8.5x7.2 RM5	
1000067326	Standard 10% Loss - Standard Dichte 6-2	Week 03/2011
	Vorlage Debitor Inland	

BARCODE „Code 39“

Packing Quantities for Capacitors with Radial Pins in PCM 2.5 mm to 22.5 mm



PCM	Size				bulk	pcs. per packing unit								
						ROLL		REEL				AMMO		
	W	H	L	Codes		S	H16.5	H18.5	ø 360	ø 500	340 x 340	490 x 370		
					N	O	F	I	H	J	A	C	B	D
2.5 mm	2.5	7	4.6	0B	5000		2200	2500			2800			
	3	7.5	4.6	0C	5000		2000	2300			2300			
	3.8	8.5	4.6	0D	5000		1500	1800			1800			
	4.6	9	4.6	0E	5000		1200	1500			1500			
	5.5	10	4.6	0F	5000		900	1200			1200			
5 mm	2.5	6.5	7.2	1A	5000		2200	2500			2800			
	3	7.5	7.2	1B	5000		2000	2300			2300			
	3.5	8.5	7.2	1C	5000		1600	2000			2000			
	4.5	6	7.2	1D	6000		1300	1500			1500			
	4.5	9.5	7.2	1E	4000		1300	1500			1500			
	5	10	7.2	1F	3500		1100	1400			1400			
	5.5	7	7.2	1G	4000		1000	1200			1200			
	5.5	11.5	7.2	1H	2500		1000	1200			1200			
	6.5	8	7.2	1I	2500		800	1000			1000			
	7.2	8.5	7.2	1J	2500		700	1000			1000			
	7.2	13	7.2	1K	2000		700	950			1000			
	8.5	10	7.2	1L	2000		600	800			800			
8.5	14	7.2	1M	1500		600	800			800				
11	16	7.2	1N	1000		500	600			640				
7.5 mm	2.5	7	10	2A	5000			2500	4400		2500			
	3	8.5	10	2B	5000			2200	4300		2300		4150	
	4	9	10	2C	4000			1700	3200		1700		3100	
	4.5	9.5	10.3	2D	3500			1500	2900		1400		2700	
	5	10.5	10.3	2E	3000			1300	2500		1300			
	5.7	12.5	10.3	2F	2000			1000	2200		1100			
	7.2	12.5	10.3	2G	1500			900	1800		1000			
10 mm	3	9	13	3A	3000			1100	2200				1900	
	4	8.5	13.5	FA	3000			900	1600				1450	
	4	9	13	3C	3000			900	1600				1450	
	4	9.5	13	3D	3000			900	1600				1400	
	5	10	13.5	FB	2000			700	1300				1200	
	5	11	13	3F	3000			700	1300				1200	
	6	12	13	3G	2400			550	1100				1000	
	6	12.5	13	3H	2400			550	1100				1000	
8	12	13	3I	2000			400	800				740		
15 mm	5	11	18	4B	2400			600	1200				1150	
	5	13	19	FC	1000			600	1200				1200	
	6	12.5	18	4C	2000			500	1000				1000	
	6	14	19	FD	1000			500	1000				1000	
	7	14	18	4D	1600			450	900				850	
	7	15	19	FE	1000			450	900				850	
	8	15	18	4F	1200			400	800				740	
	8	17	19	FF	500			400	800				740	
	9	14	18	4H	1200			350	700				650	
	9	16	18	4J	900			350	700				650	
10	18	19	FG	500			300	650				590		
11	14	18	4M	1000			300	600				540		
22.5 mm	5	14	26.5	5A	1200				800				770	
	6	15	26.5	5B	1000				700				640	
	7	16.5	26.5	5D	760				600				550	
	8	20	28	FH	500				500				480	
	8.5	18.5	26.5	5F	500				480				450	
	10	22	28	FI	570*				420				380	
	10.5	19	26.5	5G	594*				400				360	
	10.5	20.5	26.5	5H	594*				400				360	
	11	21	26.5	5I	561*				380				350	
	12	24	28	FJ	480*				350				310	

* TPS (Tray-Packing-System). Plate versions may have different packing units. Samples and pre-production needs on request.

■ Moulded versions.

Rights reserved to amend design data without prior notification.



Packing Quantities for Capacitors with Radial Pins in PCM 27.5 mm to 52.5 mm

PCM	Size				bulk	pcs. per packing unit											
						ROLL		REEL				AMMO					
	W	H	L	Codes		S	N	O	ø 360		ø 500		340 x 340		490 x 370		
								H16.5	H18.5	H16.5	H18.5	H16.5	H18.5	H16.5	H18.5	H16.5	H18.5
								F	I	H	J	A	C	B	D		
27.5 mm	9	19	31.5	6A	567*	-	-	-	-	460/340*	-	-	420				
	11	21	31.5	6B	459*	-	-	-	-	380/280*	-	-	350				
	13	24	31.5	6D	378*	-	-	-	-	300	-	-	290				
	13	25	33	FK	405*	-	-	-	-	-	-	-	-				
	15	26	31.5	6F	324*	-	-	-	-	270	-	-	250				
	15	26	33	FL	324*	-	-	-	-	-	-	-	-				
	17	29	31.5	6G	198*	-	-	-	-	-	-	-	-				
	17	34.5	31.5	6I	198*	-	-	-	-	-	-	-	-				
	20	32	33	FM	162*	-	-	-	-	-	-	-	-				
	20	39.5	31.5	6J	162*	-	-	-	-	-	-	-	-				
37.5 mm	9	19	41.5	7A	441*	-	-	-	-	-	-	-	-				
	11	22	41.5	7B	357*	-	-	-	-	-	-	-	-				
	13	24	41.5	7C	294*	-	-	-	-	-	-	-	-				
	15	26	41.5	7D	252*	-	-	-	-	-	-	-	-				
	17	29	41.5	7E	154*	-	-	-	-	-	-	-	-				
	19	32	41.5	7F	140*	-	-	-	-	-	-	-	-				
	20	39.5	41.5	7G	126*	-	-	-	-	-	-	-	-				
	24	45.5	41.5	7H	112*	-	-	-	-	-	-	-	-				
	31	46	41.5	7I	84*	-	-	-	-	-	-	-	-				
	35	50	41.5	7J	35*	-	-	-	-	-	-	-	-				
	40	55	41.5	7K	28*	-	-	-	-	-	-	-	-				
48.5 mm	19	31	56	8D	120*	-	-	-	-	-	-	-	-				
	23	34	56	8E	80*	-	-	-	-	-	-	-	-				
	27	37.5	56	8H	84*	-	-	-	-	-	-	-	-				
	33	48	56	8J	25*	-	-	-	-	-	-	-	-				
	37	54	56	8L	25*	-	-	-	-	-	-	-	-				
52.5 mm	25	45	57	9D	70*	-	-	-	-	-	-	-	-				
	30	45	57	9E	60*	-	-	-	-	-	-	-	-				
	35	50	57	9F	25*	-	-	-	-	-	-	-	-				
	45	55	57	9H	20*	-	-	-	-	-	-	-	-				
	45	65	57	9J	20*	-	-	-	-	-	-	-	-				

* for 2-inch transport pitches.

* TPS (Tray-Packing-System). Plate versions may have different packing units. Samples and pre-production needs on request.

■ Moulded versions.

Rights reserved to amend design data without prior notification.

Updated data on www.wima.com



A WIMA part number consists of 18 digits and is composed as follows:

- Field 1 - 4: Type description
- Field 5 - 6: Rated voltage
- Field 7 - 10: Capacitance
- Field 11 - 12: Size and PCM
- Field 13 - 14: Version code (e.g. Snubber versions)
- Field 15: Capacitance tolerance
- Field 16: Packing
- Field 17 - 18: Pin length (untaped)

1	2	3	4	5	6	7	8	9	10	11	12	13	14	15	16	17	18
M	K	S	2	C	0	2	1	0	0	1	A	0	0	M	S	S	D
MKS 2				63 VDC		0.01 µF			2.5x6.5x7.2		-		20%	bulk	6 -2		

<p>Type description:</p> <p>SMD-PET = SMDT SMD-PEN = SMDN SMD-PPS = SMDI FKP 02 = FKPO MKS 02 = MKS0 FKS 2 = FKS2 FKP 2 = FKP2 FKS 3 = FKS3 FKP 3 = FKP 3 MKS 2 = MKS2 MKP 2 = MKP2 MKS 4 = MKS4 MKP 4C = MKPC MKP 4 = MKP4 MKP 10 = MKP1 FKP 1 = FKP1 MKP-X2 = MKX2 MKP-X1 R = MKX1 MKP-Y2 = MKY2 MP 3-X2 = MPX2 MP 3-X1 = MPX1 MP 3-Y2 = MPY2 MP 3R-Y2 = MPRY MKP 4F = MKPF Snubber MKP = SNMP Snubber FKP = SNFP GTO MKP = GTOM DC-LINK MKP 3 = DCP3 DC-LINK MKP 4 = DCP4 DC-LINK MKP 4S = DCP5 DC-LINK MKP 5 = DCP5 DC-LINK MKP 6 = DCP6 DC-LINK HC = DCHC DC-LINK HY = DCHY</p>	<p>Rated voltage:</p> <p>50 VDC = B0 63 VDC = C0 100 VDC = D0 250 VDC = F0 400 VDC = G0 450 VDC = H0 520 VDC = H2 600 VDC = I0 630 VDC = J0 700 VDC = K0 800 VDC = L0 850 VDC = M0 900 VDC = N0 1000 VDC = O1 1100 VDC = P0 1200 VDC = Q0 1250 VDC = R0 1500 VDC = S0 1600 VDC = T0 2000 VDC = U0 2500 VDC = V0 3000 VDC = W0 4000 VDC = X0 6000 VDC = Y0 250 VAC = 0W 275 VAC = 1W 300 VAC = 2W 305 VAC = AW 350 VAC = BW 440 VAC = 4W 500 VAC = 5W ...</p>	<p>Capacitance:</p> <p>22 pF = 0022 47 pF = 0047 100 pF = 0100 150 pF = 0150 220 pF = 0220 330 pF = 0330 470 pF = 0470 680 pF = 0680 1000 pF = 1100 1500 pF = 1150 2200 pF = 1220 3300 pF = 1330 4700 pF = 1470 6800 pF = 1680 0.01 µF = 2100 0.022 µF = 2220 0.047 µF = 2470 0.1 µF = 3100 0.22 µF = 3220 0.47 µF = 3470 1 µF = 4100 2.2 µF = 4220 4.7 µF = 4470 10 µF = 5100 22 µF = 5220 47 µF = 5470 100 µF = 6100 220 µF = 6220 1000 µF = 7100 1500 µF = 7150 ...</p>	<p>Size:</p> <p>4.8x3.3x3 Size 1812 = KA 4.8x3.3x4 Size 1812 = KB 5.7x5.1x3.5 Size 2220 = QA 5.7x5.1x4.5 Size 2220 = QB 7.2x6.1x3 Size 2824 = TA 7.2x6.1x5 Size 2824 = TB 10.2x7.6x5 Size 4030 = VA 12.7x10.2x6 Size 5040 = XA 15.3x13.7x7 Size 6054 = YA 2.5x7x4.6 PCM 2.5 = 0B 3x7.5x4.6 PCM 2.5 = 0C 2.5x6.5x7.2 PCM 5 = 1A 3x7.5x7.2 PCM 5 = 1B 2.5x7x10 PCM 7.5 = 2A 3x8.5x10 PCM 7.5 = 2B 3x9x13 PCM 10 = 3A 4x9x13 PCM 10 = 3C 5x11x18 PCM 15 = 4B 6x12.5x18 PCM 15 = 4C 5x14x26.5 PCM 22.5 = 5A 6x15x26.5 PCM 22.5 = 5B 9x19x31.5 PCM 27.5 = 6A 11x21x31.5 PCM 27.5 = 6B 9x19x41.5 PCM 37.5 = 7A 11x22x41.5 PCM 37.5 = 7B 19x31x56 PCM 48.5 = 8D 25x45x57 PCM 52.5 = 9D ...</p> <p>Version code:</p> <p>Standard = 00 Version A1 = 1A Version A1.1.1 = 1B Version A2 = 2A ...</p>	<p>Tolerance:</p> <p>±20% = M ±10% = K ±5% = J ±2.5% = H ±1% = E ...</p> <p>Packing:</p> <p>AMMO H16.5 340x340 = A AMMO H16.5 490x370 = B AMMO H18.5 340x340 = C AMMO H18.5 490x370 = D REEL H16.5 360 = F REEL H16.5 500 = H REEL H18.5 360 = I REEL H18.5 500 = J ROLL H16.5 = N ROLL H18.5 = O BLISTER W12 180 = P BLISTER W12 330 = Q BLISTER W16 330 = R BLISTER W24 330 = T Bulk/TPS Standard = S ...</p> <p>Pin length (untaped)</p> <p>3.5 ±0.5 = C9 6 -2 = SD 16 ±1 = P1 ...</p> <p>Pin length (taped)</p> <p>none = 00</p>
--	--	---	--	---

The data on this page is not complete and serves only to explain the part number system. Part number information is listed on the pages of the respective WIMA range.